

# Data Sheet



Article number: 021500700113

Description: Sealing Clamp S 113 W5

## Measures

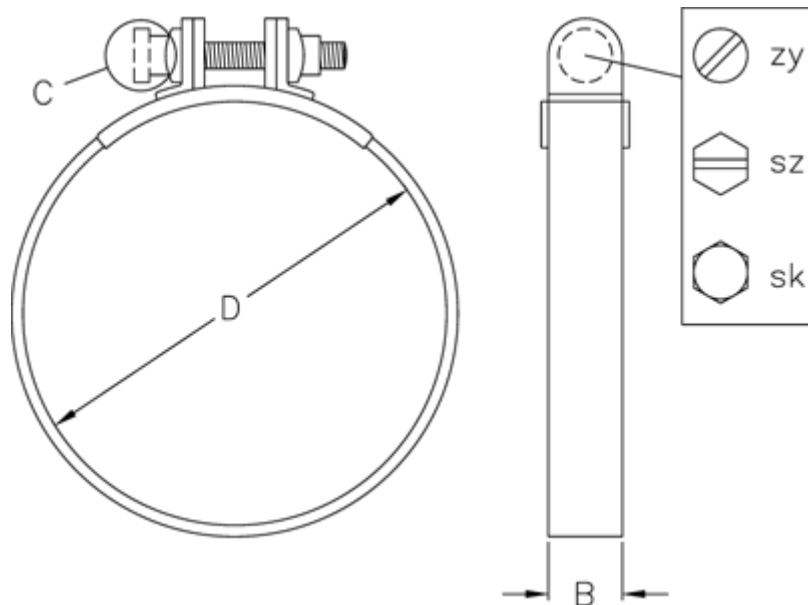

C (screw type)	= SZ
Diameter D	= 113
Width B	= 20